



ARIES 46



ARIES 26



ARIES 16

ARIES 16/26/46

Series 8905, 8915, 8925

WALL MOUNT VENT FREE GAS FIREPLACES

OEM Models# VF-16NG, VF-16LP, VF-26NG, VF-26LP, VF-46NG, VF-46LP

Owner's Manual Installation & Operating Instructions

Read This Manual in Its Entirety
Operate and Maintain This Gas Heater
According to This Instruction Manual.

SAVE THESE INSTRUCTIONS





Report #0361GF005S



WARNING:

FIRE OR EXPLOSION HAZARD

Failure to follow safety warnings exactly could result in serious injury, death, or property damage.

-  Do not store or use gasoline or other flammable vapors and liquids in the vicinity of this or any other appliance.
-  **WHAT TO DO IF YOU SMELL GAS:**
 - Do not try to light any appliance.
 - Do not touch any electrical switch; do not use any phone in your building.
 - Leave the building immediately.
 - Immediately call your gas supplier from a neighbor's phone. Follow the gas supplier's instructions.
 - If you cannot reach your gas supplier, call the fire department or 911.
-  A qualified installer, service agency, or gas supplier must perform installation and service of this appliance. In the Commonwealth of Massachusetts, all installation of gas lines and gas fittings must be performed by a licensed gas fitter or licensed plumber.

DANGER



**HOT GLASS WILL
CAUSE BURNS.**

**DO NOT TOUCH GLASS
UNTIL COOLED.**

**NEVER ALLOW CHILDREN
TO TOUCH GLASS.**

A barrier designed to reduce the risk of burns from the hot viewing glass is provided with this appliance and shall be installed for the protection of children and other at-risk individuals.

California Prop 65

 **WARNING:** This product can expose you to chemicals including glass wool fiber and carbon monoxide which are known to the State of California to cause cancer, birth defects or other reproductive harm. For more information go to www.P65Warnings.ca.gov

Ce manuel est disponible en Francais a
www.hearthstonetech.com

INDEX

IMPORTANT SAFETY INFORMATION.....	4
ROOM FOR VENT FREE.....	6
SPECIFICATIONS.....	8
ASSEMBLY & INSTALLATION.....	12
GAS CONNECTION.....	13 & 15
LIGHTING AND OPERATION.....	20
MAXITROL CONTROL SYSTEM.....	23
MAINTENANCE.....	29
MAINTENANCE LOG FORMS.....	31
INSTALLATION RECORD.....	32
REPLACEMENT PARTS LIST.....	33
CONTROL SCHEMATIC.....	34
TROUBLESHOOTING.....	35
WARRANTY INFORMATION.....	37

WE STRONGLY SUGGEST THAT YOU READ THIS MANUAL THOROUGHLY BEFORE BEGINNING THE INSTALLATION OF THE ORION 46 DIRECT VENT GAS FIREPLACE. ALTHOUGH THE BASIC REQUIREMENTS FOR THE INSTALLATION OF ALL DIRECT VENT GAS FIREPLACES ARE SIMILAR, EACH SPECIFIC PRODUCT HAS ITS OWN UNIQUE SET-UP AND INSTALLATION REQUIREMENTS THAT MUST BE FOLLOWED EXACTLY. PLAN YOUR INSTALLATION IN ADVANCE BY CAREFULLY REVIEWING ALL THE INFORMATION CONTAINED IN THIS MANUAL.

POÊLE AU GAZ À VENTILATION DIRECTE

Manuel de l'Utilisateur

Lire ce Manuel en Entier



Utiliser et Entretienir ce Poêle au Gaz
selon ce Manuel d'Instructions

CONSERVER CES INSTRUCTIONS!

AVERTISSEMENT:

RISQUE D'INCENDIE OU D'EXPLOSION

**Le non-respect des avertissements de sécurité
serait exactement entraîner des blessures graves,
la mort ou des dommages matériels.**

-  Ne pas entresposer ni utiliser d'essence ni d'autre vaperurs ou liquides inflammables dans le voisinage de cet appareil ou de tout autre appareil.
-  **QUE FAIRE SI VOUS SENTEZ UNE ODEUR DE GAZ:**
 - Ne pas tenter d'allumer d'appareil.
 - Ne touchez à aucun interrupteur. Ne pas vous servir des téléphones se trouvant dans le bâtiment où vous vous trouvez.
 - Quittez le bâtiment immédiatement.
 - Appelez immédiatement votre fournisseur de gaz depuis un voisin. Suivez les instructions du fournisseur.
 - Si vous ne pouvez rejoindre le fournisseur de gaz, appelez le service dos incendies
-  L'installation et l'entretien doivent être assurés par un installateur ou un service d'entretien qualifié ou par le fournisseur de gaz.

 **DANGER**



**UNE VITRE CHAUDE PEUT
CAUSER DES BRÛLURES.
NE PAS TOUCHER UNE
VITRE AVANT QU'ELLE NE
REFROIDISSE.
NE JAMAIS LAISSER UN
ENFANT TOUCHER À LA VITRE.**

Une barrière de sécurité est recommandée pour réduire les risques de brûlures causées par la vitre chaude de cet appareil et doit être installée pour la protection des enfants et d'autres personnes à risque.

Important Safety Information

WARNING:

- Any change to this heater or its controls can be dangerous.
- Improper installation or use of the heater can cause serious injury or death from fire, burns, explosion or carbon monoxide poisoning.
- Do not allow fans to blow directly into the fireplace. Avoid any drafts that alter burner flame patterns.
- Do not use a blower insert, heat exchanger insert or other accessory, not approved for use with this heater.

1. Due to high temperatures, the heater should be located out of traffic and away from furniture and draperies.
2. Children and adults should be alerted to the hazard of high surface temperature and should stay away to avoid burns or clothing ignition.
3. Young children should be carefully supervised when they are in the same room with the heater.
4. Do not place clothing or other flammable material on or near the heater.
5. Any safety screen or guard removed for servicing an appliance, must be replaced prior to operating the heater.
6. Installation and repair should be done by a qualified service person. The heater should be inspected before use and at least annually by a professional service person. More frequent cleaning may be required due to extensive lint from carpeting, bedding material, etc. It is imperative that control compartments, burners and circulating air passageways of the heater be kept clean.
7. To prevent malfunction and/or sooting, an unvented gas heater should be cleaned before use and at least annually by a professional service person.
8. **CARBON MONOXIDE POISONING:** Early signs of carbon monoxide poisoning are similar to the flu with headaches, dizziness and/or nausea. If you have these signs, obtain fresh air immediately. Have the heater serviced as it may not be operating properly.
9. The installation must conform with local codes or, in the absence of local codes, with the National Fuel Gas Code, ANSI Z223.1/NFPA54.
10. This unit was tested and listed to ANSI Z21.11.2-2011 by OMNI-Test Laboratories.
11. This appliance is approved for installation in the Commonwealth of Massachusetts. The Board of State Examiners of Plumbers and Gas Fitters has approved these appliances.
12. Do not install this heater in a bathroom or bedroom.
13. Correct installation of the fire media, proper location of the heater, and annual cleaning are necessary to avoid potential problems with sooting. Sooting, resulting from improper installation or operation, can settle on surfaces outside the fireplace. See media placement instructions for proper installation.

14. **WARNING:** Avoid any drafts that alter burner flame patterns. Do not allow fans to blow directly into fireplace. Do not place a blower inside burn area of firebox. Ceiling fans may create drafts that alter burner flame patterns. Sooting and improper burning will occur.
15. **Caution:** Candles, incense, oil lamps, etc. produce combustion by-products including soot. Vent Free heaters will not filter or clean soot produced by these types of products. In addition, the smoke and/or aromatics (scents) may be reburned in the vent free heater which can produce odors. It is recommended to minimize the use of candles, incense, etc. while the vent free heater is in operation.
16. Keep room area clear and free from combustible materials, gasoline and other flammable vapors and liquids.
17. This appliance is intended for supplemental heating.
18. Unvented gas heaters emit moisture into the living area. In most homes of average construction, this does not pose a problem. In houses of extremely tight construction, additional mechanical ventilation is recommended.
19. During manufacturing, fabricating and shipping, various components of this heater are treated with certain oils, films or bonding agents. These chemicals are not harmful but may produce annoying smoke and smells as they are burned off during the initial operation of the heater; possibly causing headaches or eye or lung irritation. This is a normal and temporary occurrence. The initial break-in operation should last four to six hours with the burner at the highest setting. Provide maximum ventilation by opening windows or doors to allow odors to dissipate. The amount of time required for the initial break-in is dependent on a number of variables determined by your specific installation including but not limited to surfaces and surface finishes adjacent to the fireplace which may off gas for some period of time. Any odors remaining after this initial break-in period will be slight and will disappear with continued use.
20. Input ratings are shown in BTU per hour and are for elevations up to 2,000 feet. If your installation is at an elevation greater than these, consult with the local authority having jurisdiction for gas product installations to determine their specific requirements for high altitude installations.
21. The heater must be isolated from the gas supply piping system by closing its equipment shutoff valve during any pressure testing of the gas supply piping system at test pressures equal to or less than 1/2 psi (3.5 kPa).
22. Do not use this room heater if any part has been under water. Immediately call a qualified service technician to inspect the heater and to replace any part of the control system and any gas control which has been under water.
23. Never burn solid fuels in a fireplace where an unvented heater is installed.
24. **WARNING:** Any change to this heater or its controls can be dangerous.

Room Volume for Vent Free

CODES

Adhere to all local codes or, in their absence, the latest edition of THE NATIONAL FUEL GAS CODE ANSI Z223.1 or NFPA54 which can be obtained from...

American National Standards Institute, Inc.
1430 Broadway New York, NY 10018

or

National Fire Protection Association, Inc.
Batterymarch Park Quincy, MA 02269

ADEQUATE COMBUSTION AND VENTILATION AIR

This heater shall not be installed in a confined space or unusually tight construction unless provisions are provided for adequate combustion and ventilation air.

The National Fuel Gas Code, (ANSI Z223.1/NFPA 54), defines a *confined* space as a space whose volume is less than 50 cubic feet per 1,000 BTU per hour (4.8 m³ per kw) of the aggregate input rating of all appliances installed in that space. An *unconfined* space is defined as a space whose volume is not less than 50 cubic feet per 1,000 BTU per hour (4.8 m³ per kw) of the aggregate input rating of all appliances installed in that space. Rooms communicating directly with the space in which the appliances are installed, through openings not furnished with doors, are considered a part of the unconfined space.

UNUSUALLY TIGHT CONSTRUCTION IS DEFINED AS CONSTRUCTION WHERE...

- walls and ceilings exposed to the outside atmosphere have a continuous water vapor retarder with a rating of 1 perm (6 x 10⁻¹¹ kg per pa-sec-m²) or less with openings gasketed or sealed;
- weather stripping has been added on operable windows and doors, and
- caulking or sealants are applied to areas such as joints around window and door frames, between sole plates and floors, between wall-ceiling joints, between wall panels, at penetrations for plumbing, electrical, and gas lines, and at other openings.

WARNING:

This heater shall not be installed in a room or space unless the required volume of indoor combustion air is provided by the method described in the National Fuel Gas Code, ANSI Z223.1/NFPA 54, the International Fuel Gas Code, or applicable local codes.

The following formula can be used to determine the maximum heater rating (per the definition of unconfined space) that is allowed in your space:

$$\text{Maximum BTU/Hr.} = \frac{(L)\text{ft} \times (W)\text{ft} \times (H)\text{ft}}{50} \times 1000$$

Example A: Consider a room with the following dimensions: L=16ft, W=14ft, H=8ft

$$\frac{(16)\text{ft} \times (14)\text{ft} \times (8)\text{ft}}{50} \times 1000 = 35,840 \text{ BTU/Hr.}$$

Example B: Consider a room with the following dimensions: L1=16ft, W1=14ft, H1=8 which is communicating directly with the space in a second room through openings not furnished with doors having the following dimensions: L2=14ft, W2=12ft, H2=8

$$\text{Maximum BTU/Hr.} = \frac{((L1)\text{ft} \times (W1)\text{ft} \times (H1)\text{ft}) + ((L2)\text{ft} \times (W2)\text{ft} \times (H2)\text{ft})}{50} \times 1000$$

With data input into the equation:

$$\frac{((16)\text{ft} \times (14)\text{ft} \times (8)\text{ft}) + ((14)\text{ft} \times (12)\text{ft} \times (8)\text{ft})}{50} \times 1000 = 62,720 \text{ BTU/Hr.}$$

Will my space support an ARIES Wall Mount Vent Free Gas Fireplace?

Maximum BTU/Hr. my space will support (use formula above) a) _____

BTU/hr. of ARIES Wall Mount Vent Free Gas Fireplace b) _____

If the answer to a) is **greater** than b) then your space **will** support the installation of a AURORA Wall Mount Vent Free Gas Fireplace; if a) is **less** than b) then your space **will not** support a AURORA Wall Mount Vent Free Gas Fireplace.

Bringing in Outside (or “Make-up”) Air:

Many building code jurisdictions require that outside or “make-up” air be provided when installing a fireplace of this type. This requirement can be satisfied by the proper installation of an ‘outside air kit’ which is not provided. The final determination of the suitability of any particular kit must be made by the installer.

If an outside air supply is desired it should be added to the room in which the AURORA Wall Mount Vent Free Gas Fireplace is installed, not to the chase enclosing the fireplace.

If outside air is introduced into the chase, competing air pressures could compromise the operation of the fireplace.

Specifications

NATURAL GAS SPECIFICATION CHART			
<u>INPUT</u>	ARIES 16 VF	ARIES 26 VF	ARIES 46 VF
Input Rating BTU/Hr.	16,000	26,000	37,000
Min. Input BTU/Hr.	12,500	16,000	23,000
Orifice Size - DMS	#51	#46	#38
<u>GAS SUPPLY</u>	ARIES 16 VF	ARIES 26 VF	ARIES 46 VF
Manifold Pressure	4.8"w.c. / 1.2kPa	4.8"w.c. / 1.2kPa	3.9"w.c. / 1.0kPa
Min. Supply Pressure	5.5"w.c. / 1.4kPa	5.5"w.c. / 1.4kPa	5.5"w.c. / 1.4kPa
Max. Supply Pressure	10.0"w.c. / 2.5kPa	10.0"w.c. / 2.5kPa	10.0"w.c. / 2.5kPa

PROPANE (LP) SPECIFICATION CHART			
<u>INPUT</u>	ARIES 16 VF	ARIES 26 VF	ARIES 46 VF
Input Rating BTU/Hr.	18,000	30,000	37,000
Min. Input BTU/Hr.	11,000	19,000	25,000
Orifice Size – DMS	#55	#52	#50
<u>GAS SUPPLY</u>	ARIES 16 VF	ARIES 26 VF	ARIES 46 VF
Manifold Pressure	10.0"w.c. / 2.5kPa	10.0"w.c. / 2.5kPa	10.0"w.c. / 2.5kPa
Min. Supply Pressure	11.0"w.c. / 2.8kPa	11.0"w.c. / 2.8kPa	11.0"w.c. / 2.8kPa
Max. Supply Pressure	13.0"w.c. / 3.3kPa	13.0"w.c. / 3.3kPa	13.0"w.c. / 3.3kPa

- It is recommended that the pilot flame be turned off if the appliance will not be in use for an extended period of time.
- This appliance is equipped for use with the fuel type indicated on the rating plate. Field conversion is not permitted.

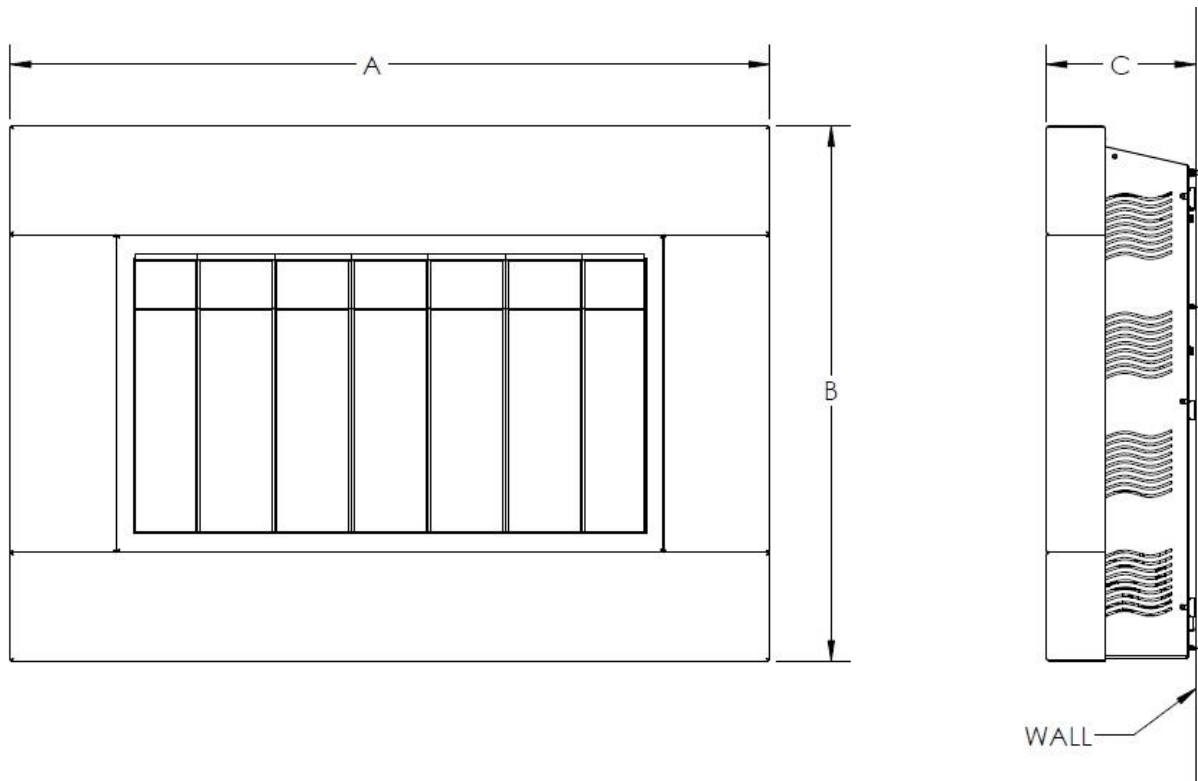

	ARIES 16 VF	ARIES 26 VF	ARIES 46 VF
Dimension "A"	23 1/2"	38 1/4"	58 3/8"
Dimension "B"	30"	27 1/4"	25 1/4"
Dimension "C"	7 5/8"	7 5/8"	8"

OTHER CONSIDERATIONS:

Several issues must be addressed when selecting a suitable location for your ARIES Wall Mount Vent Free Gas Fireplace. The minimum clearances to combustible construction is listed on the following page. In addition, access to the gas supply must be considered and room volume for vent free combustion (see pages 4 & 5).

The gas fireplace is shipped with a 3/8" tube OD (male) connection. The gas supply piping should have a separate gas shutoff valve and a 1/8" NPT plugged tapping upstream of the valve. The stove and its main control valve must be disconnected from the gas supply piping system during any pressure testing of that system at test pressures in excess of 1/2 psi (3.5 kPa). The stove must be isolated from the gas supply piping system by closing the main control valve during any pressure testing of the gas supply system at test pressures equal to or greater than 1/2 psi (3.5 kPa). After the gas supply has been connected, use a commercial gas leak detector or apply a soapy water solution to all the fittings to check for gas leaks. Never use a flame to test for leaks.

MINIMUM CLEARANCES TO COMBUSTIBLE CONSTRUCTION			
	ARIES 16 VF	ARIES 26 VF	ARIES 46 VF
Fireplace to Left Side Wall - (Dimension "A")	6"	6"	6"
Fireplace to Right Side Wall - (Dimension "A")	6"	6"	6"
Fireplace to Corner Side Wall - (Dimension "B")	6"	6"	6" *
Fireplace to Ceiling (Dimension "C")	12"	12"	12"
Fireplace to Floor (Dimension "D")	3" **	3" **	3" **
Fireplace to Rear Wall	0" ***	0" ***	0" ***
Air Space Behind Mounting Plate (Dimension "E")	5/16"	5/16"	3/8"
Floor to Ceiling Overall Minimum Dimension	45"	42 1/4"	40 1/4"

*Optional Corner Kit not available for the ARIES VF

**The minimum required clearance to be maintained from the fireplace to combustible flooring is measured from the top surface of carpeting, tile, etc.

***Mounting plate bosses contact the wall.

Intentionally Left Blank

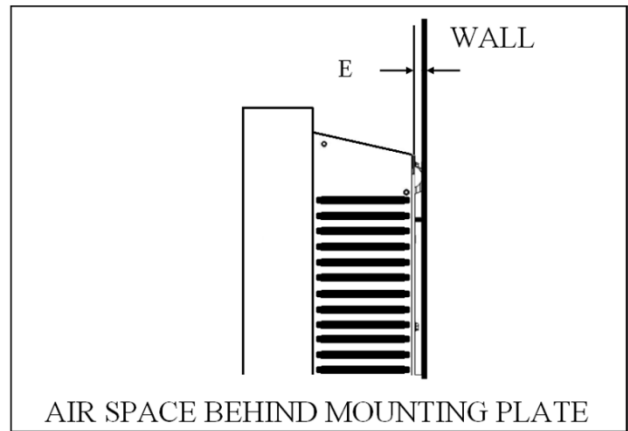
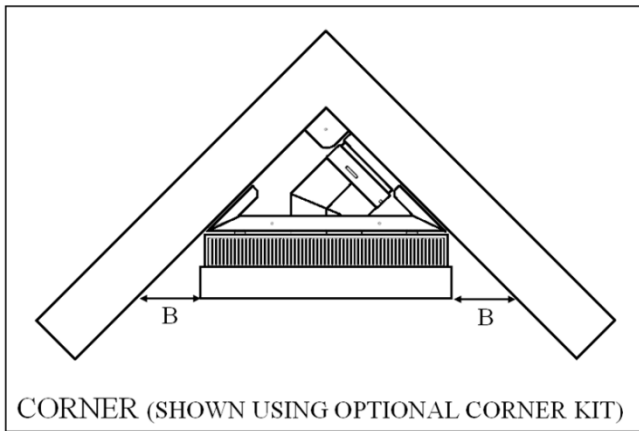
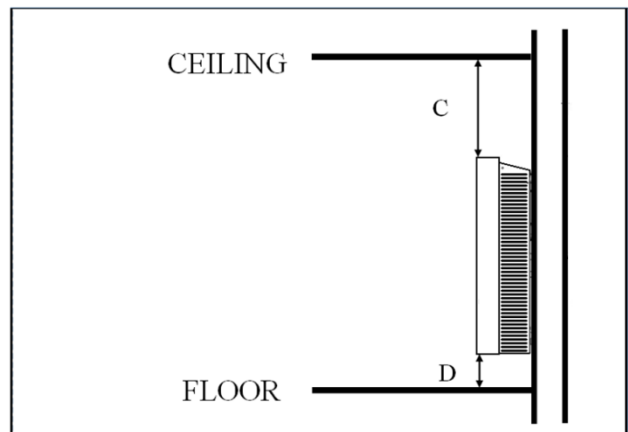
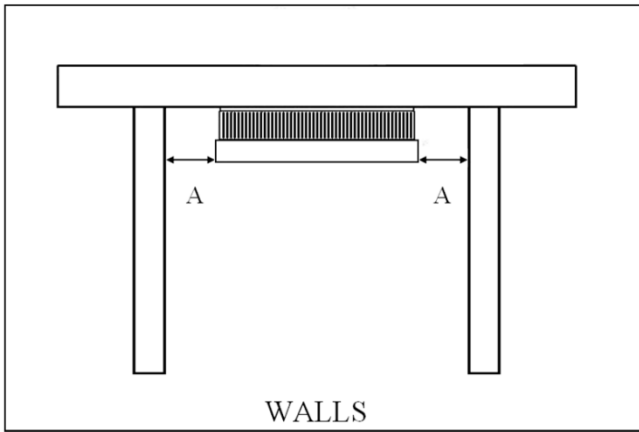

CERTIFICATION

OMNI-Test Laboratories, Inc. has certified that the ARIES Wall Mount Vent Free Gas Fireplaces meet the ANSI Z21.11.2-2011 standard.

These appliances are approved for installation in the Commonwealth of Massachusetts. The Board of State Examiners of Plumbers and Gas Fitters has issued approved these appliances.

Intentionally Left Blank

Assembly & Installation

UNPACKING AND INSTALLING THE ARIES VENT FREE GAS FIREPLACE

The fireplace components are shipped in two cartons. By now, you will have opened the top of the first carton and removed the front face protector and this Manual. The second carton contains the fireplace surround assembly.

1. Using the adjacent illustrations as a guide, first lift and remove Tube 1 from the carton containing the firebox. Carefully unpack the contents of the tube and set aside. This should include the bag of glass burner media, the remote control handset, and a hardware bag.
2. Next lift and remove Tube 2 from the carton. Carefully remove the contents of the tube. This includes the four decorative panels that will be attached to the fireplace during assembly.
3. Next, remove all remaining packing material from the carton.
4. Lift the firebox and the fireplace mounting plate as a unit up and out of the carton. The best place to lift is at sides. Remove the fireplace mounting template from the face of the fireplace. You should now have all of the parts as shown in the illustration below.
5. Finally, unpack the fireplace surround from the third carton and set aside on a soft surface for later use.

Before you begin the fireplace mounting process there are several important installation requirements that must be met. Careful planning will make the installation easier to accomplish and will reduce the chances of encountering problems during installation.

1. The fireplace is designed to be wall-mounted using four lag bolts to secure the fireplace mounting plate to the wall structure. The mounts are located 16" on center and 24" on center to correspond with standard building construction. If your home has non-standard construction or the location you have chosen

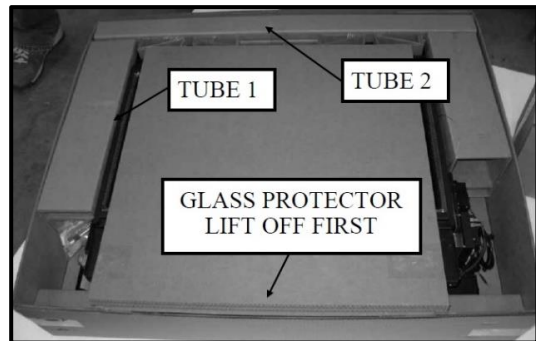

for the fireplace does not have wall studs that correspond to location of the fireplace mounts, modifications to the wall structure will be needed. It is critical that the four lag bolts that are provided for mounting the fireplace are firmly imbedded into the wall structure at all four locations.

2. All required minimum clearances to adjacent combustible materials (including side walls, ceiling and floor) must be achieved with the location you have chosen. See the clearance information on page 10. The listed clearances are measured from the outermost front edges of the fireplace surround and not from the fireplace body or mounting plate. Again, plan the installation in advance to avoid problems.
3. The gas supply line must be located within a specific area behind the fireplace. Use the provided wall template as a guide when locating the gas supply line pass-through.

Once you are certain that the location you have chosen meets all the necessary mounting and safety requirements, you can begin the installation.

1. Tape or pin the installation template to the wall in the position where the fireplace is to be mounted. Note: It is important that the fire-place is mounted in a level position. Use a spirit level placed on the cross-hairs in the upper mounting holes on the template and adjust the template position until the mounting holes are level. Refer to the adjacent illustration.
2. Next, carefully transfer the location of the two upper and two lower mounting holes that you will use for your installation. Use a sharp nail, awl or pin to pierce the template on the mounting hole cross-hairs to insure an accurate transfer to your wall.
3. Finally, transfer the location of the gas supply line.
4. Remove the template and circle the transferred locations with a pencil or marker.

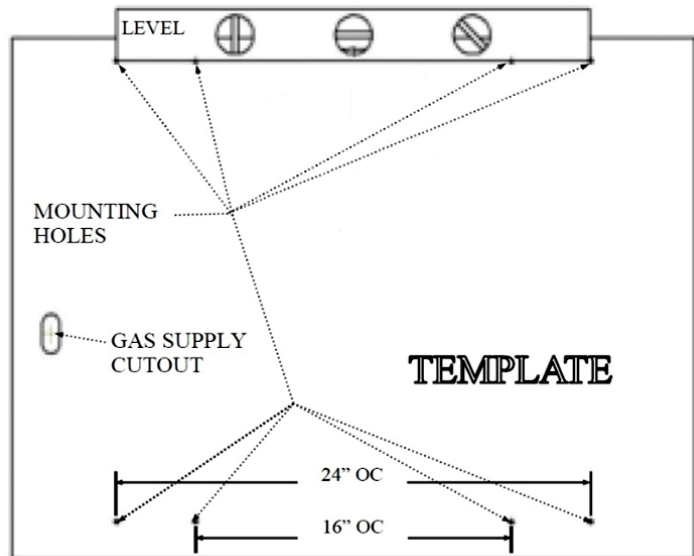

GAS SUPPLY LINE

The supply line should exit the wall that the fireplace will be installed on at the location specified on the installation template we suggest the installation of a shut-off valve in the supply line between the wall and the connection to the fireplace. Your professional gas installer or local gas company will determine the specific requirements for the gas supply line as the requirements may vary in different locations. In every case, the installation must conform with local codes or, in the absence of local codes, with the National Fuel Gas Code, ANSI Z223.1.

INSTALLING THE FIREPLACE MOUNTING PLATE ON THE WALL

1. The fireplace mounting plate is attached to the wall structure using four 1/4" X 1 1/2" long lag bolts and large diameter washers that are provided with the fireplace. It is important to use the included hardware as the full weight of the fireplace is supported by the mounting plate.
2. Drill a 5/32" diameter pilot hole at each of the mounting hole locations that you marked using the template. The pilot holes should be the full depth of the lag bolts. Be sure that there is solid wood at each mounting location. If not, the wall should be reconstructed to provide the needed support.
3. With a helper pick up and align the mounting plate over the gas supply line and line up with the four mounting lag bolt pilot holes. These holes are in recessed bosses. Use either the 16" or 24" on center holes depending on the construction of the wall.
4. Using the lag bolts and washers provided with the fireplace, install the top lag bolts (with washers) first, followed by the lower ones. Use a 7/16" socket wrench to tighten the lag bolts. Note: It may be helpful to put a light coating of dish or hand soap on the lag bolts to reduce resistance when tightening.
5. At this point, check to be sure that there is an air gap between the entire flat back surface of the mounting plate and the wall surface (see clearance chart on page 9 for the air gap required for your model). This gap is critical to a safe installation and if the gap is obstructed in any way, remove the obstruction before proceeding.

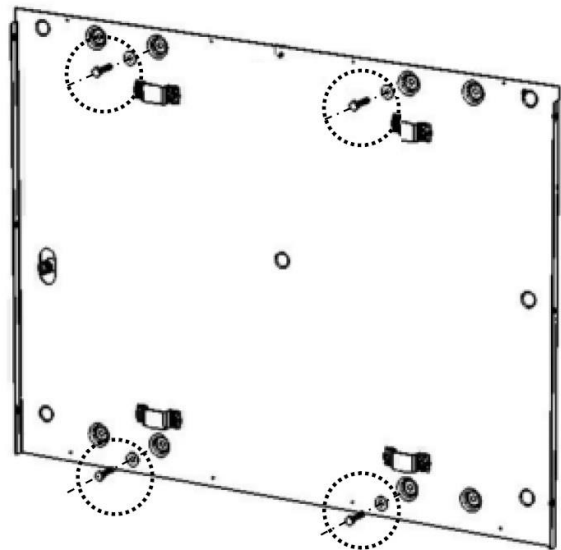
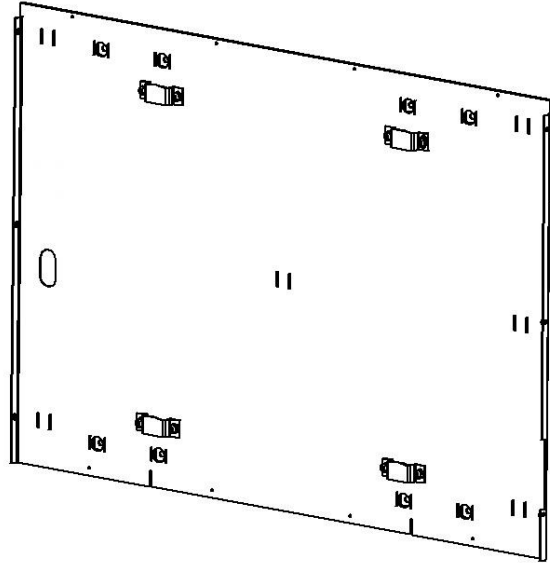

LAG BOLTS & WASHERS

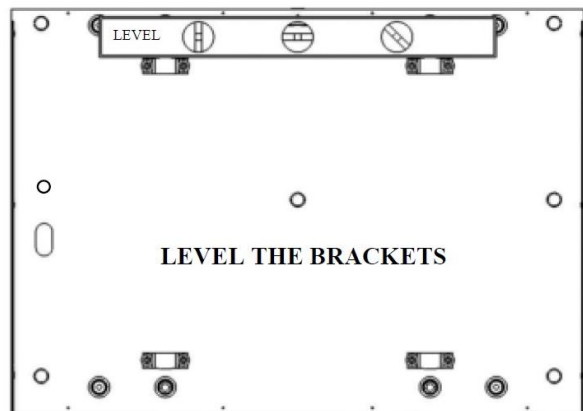

6. Next check that the brackets on the mounting plate that actually hold the fireplace are level, again using a spirit level. If the brackets are not perfectly level, you can adjust the right bracket by loosening the bracket fasteners and moving the bracket until it is level with the left bracket. Remember to tighten the bracket fasteners once you have achieved a level position. (refer to images on following page)
7. You are now ready to install the fireplace on the mounting plate, this will require a helper as the fireplace is quite heavy.
8. While looking in from the sides, guide the upper and lower mounting tabs on the back of the fire-place into the corresponding brackets on the mounting plate. When the tabs and brackets are aligned, push the fireplace down and in to engage the tabs in the brackets. Note: The weight of the fireplace is carried only on the top brackets. The bottom brackets function simply to keep the bottom of the fireplace from moving. Refer to the adjacent illustration.
9. Once more, confirm that the fireplace is level using the spirit level used in the preceding steps. The fireplace is now ready for the gas connection to be made.

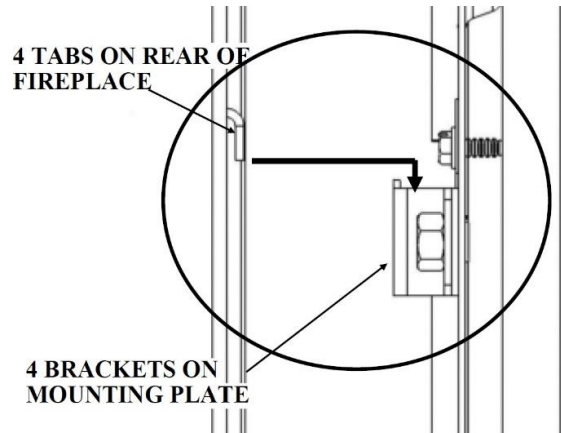

GAS CONNECTION

1. Verify that the gas type is correct for the fireplace by looking at the rating plate that is attached to the right side of the fire-place, adjacent to the control battery pack. Note: The fireplace is shipped from the factory equipped to burn the fuel listed on the rating plate. Fuel conversion in the field is not allowed.
2. The gas connection should now be made from the gas supply line to the 3/8 OD Tube fitting on the fireplace. Only a qualified gas installer is to make the connection.
3. The gas supply piping should have a separate gas shut-off valve and a 1/8" NPT plugged tapping upstream of the valve. We recommend installing a shut-off valve between the gas supply line where it penetrates the wall / fireplace mounting plate and the inlet on the fireplace. This will allow gas to be shut-off to the fireplace by simply removing the fireplace surround to gain access to the shut-off valve.
4. The fireplace and its main burner valve must be disconnected from the gas supply piping system during any pressure testing of that system at test pressures in excess of 1/2 psi (3.5kPa).

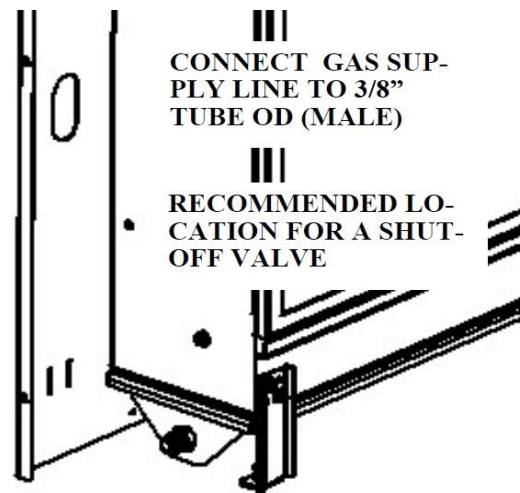

- The fireplace must be isolated from the gas supply piping system by closing the gas shut-off valve during any pressure testing of the gas supply system at test pressures equal to or less than 1/2 psi (3.5kPa). After the gas supply has been connected, use a commercial gas leak detector or apply a soapy water solution to all the fittings to check for gas leaks. Never use a flame to test for leaks.

Installing or Replacing the Batteries

- The valve control module is powered by four “AA” batteries. The batteries are mounted within the Valve Receiver Module located on the right side of the fireplace attached to a drop-down mounting bracket for easy accessibility. Refer to the adjacent illustration.
- Loosen the thumb screw on the module drop-down mounting bracket by turning counter-clockwise until the threads are fully disengaged from the base bracket.
- Rotate the Valve Receiver Module and mounting bracket. Toward you 90 degrees.
- Slide off the Battery compartment cover.
- Install the 4 “AA” batteries, supplied, using the guides inside the battery pack to show you the correct battery orientation.
- Replace the battery compartment cover. Rotate the Valve Receiver Module and mounting bracket into its home position and tighten the thumb screw to secure.
- The remote handset is powered by three “AAA” batteries. The access panel is located on the back of the handset and simply snaps open to provide access to the battery compartment. Install the three batteries as shown on the label inside the remote control battery compartment.
- Replace the remote handset access panel.

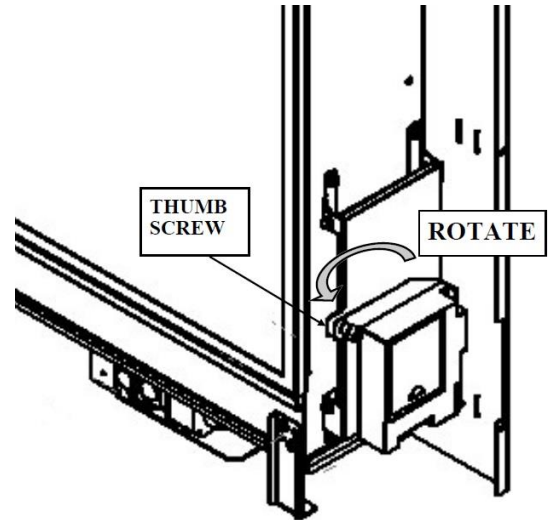

Placing the Burner Glass Media

The burner glass media poly-bag that you set aside when you unpacked the fireplace contains the correct amount of glass material to cover the burner. DO NOT add any additional media to the media

supplied with your fireplace. The entire contents of the bag should be evenly distributed over the burner tray.

1. Locate the burner in the fireplace. Refer to the adjacent illustration.
2. Carefully clip one corner of the poly-bag to form a pouring spout. The opening should be large enough to allow the glass media to flow but not so large that you can't control the flow.
3. You will notice that the burner surface is designed with turned-up edges that form a tray to hold the glass media.
4. Starting at one end, pour the glass media onto the burner tray, keeping the pouring spout on the poly-bag toward the center of the burner to avoid spillage of glass pieces over the sides of the burner. See the adjacent illustrations.
5. Once you have poured all of the glass burner media into the burner tray, carefully smooth the glass pieces out so they have a uniform depth over the entire surface of the burner. When the burner glass media is properly placed, it should look like the adjacent illustrations.

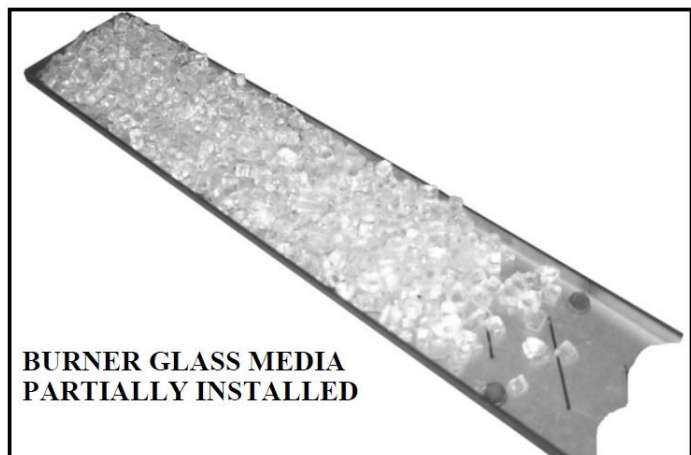
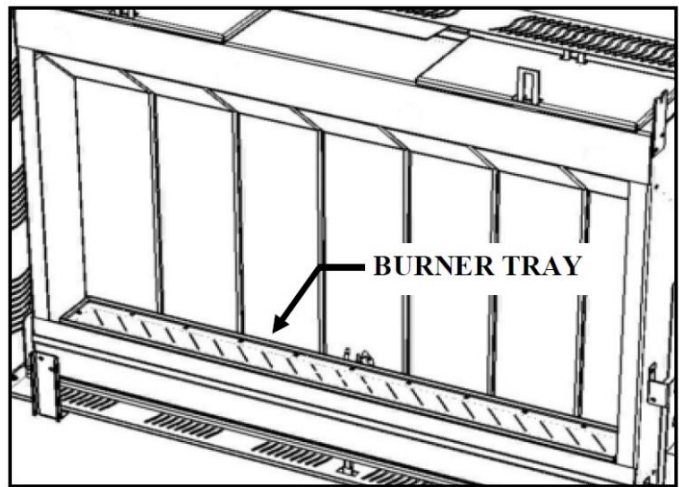

Note: If a few pieces of glass escape over the edges of the burner tray during installation, it is not a problem. They will simply land in the area below the burner and will do no harm.

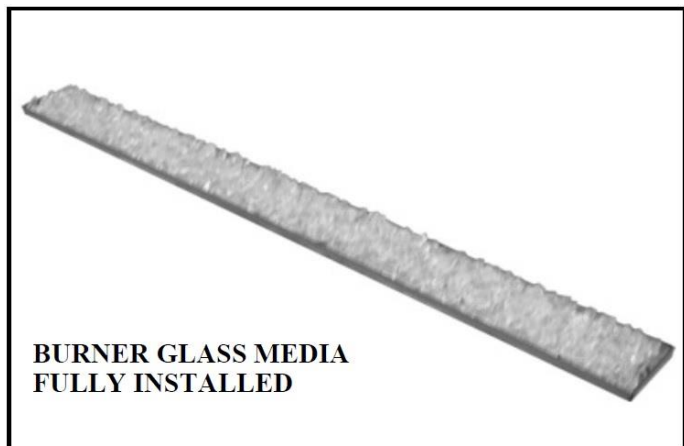

INSTALLING OUTER PANELS

1. The four outer decorative panels are secured to the fire-place with Philips head screws. The top and bottom panels are secured to the fireplace mounting plate with sheet metal screws. All other screws are Philips head machine screws.
2. Install the top panel first. Align the three holes along the rear edge of the panel with pilot holes along the top edge of the fireplace mounting plate.
3. Insert and tighten the three sheet metal screws. A magnetic nut driver is helpful.
4. Install the left side panel next. Align the three holes along the rear edge of the panel with the PEM nuts along the edge of the fireplace mounting plate. Insert the three Philips head screws but do not fully tighten.
5. Locate the fastener hole at the top front edge of the left side panel and align with the PEM nut in the front of the top panel. Insert the Philips head screw.
6. Make sure the edges of the panel are aligned with the edges of the top panel and mounting plate and tighten all four Philips head screws.
7. Position the right side panel so it aligns with the three PEM nuts on the mounting plate and the front PEM nut on the top panel. Align the rear and top panel edges with the adjoining parts and insert and tighten the four Philips head screws.
8. Install the bottom panel next. Guide the rear flange on the panel upward until the mounting holes in the flange line up with the pilot holes in the mounting plate.
9. Attach the panel to the mounting plate using sheet metal screws along the back edge of the panel. Note: It may make installation of the sheet metal screws easier if you remove the two lower surround mounting brackets from the front of the fireplace, replace brackets before operating fireplace. A magnetic nut-driver will also be helpful.
10. Attach the bottom panel to the side panels by aligning the fastener holes in the bottom panel with the PEM nuts in the front corners of the bottom flanges on the side panels. Insert and tighten the two Philips head screws.

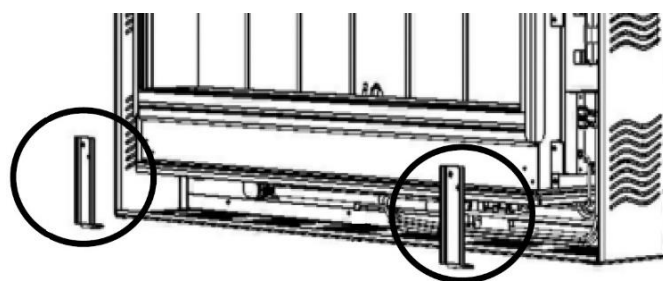
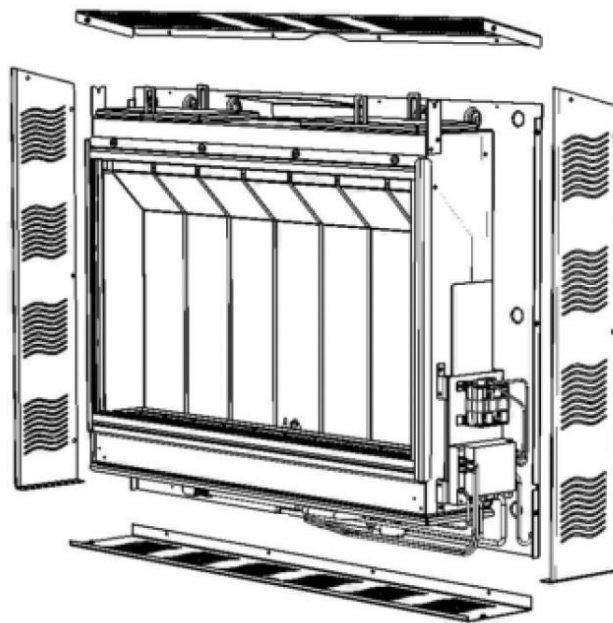

LOWER SURROUND BRACKETS

Only trim kit(s) supplied by the manufacturer shall be used in the installation of this appliance.

INSTALLING THE FIREPLACE SURROUND WITH INTEGRATED SCREEN

The decorative surround with integrated screen for the fireplace is held in place by four brackets. Two are located on the top of the fireplace and two on the bottom. There are mating brackets and catch plates on the surround itself. Refer to the adjacent illustrations when installing the surround.

1. Unpack the surround with integrated screen from shipping box.
2. With a helper, lift the surround with integrated screen up and identify the top by looking for the vertical brackets that are visible from the rear of the surround.
3. Move the surround with integrated screen into place, generally centering the surround opening over the glass panel. Keep the bottom of the surround tipped slightly away from the fireplace.
4. While looking behind the surround with integrated screen, guide the two surround brackets onto the forward detent of the mating brackets on the fireplace top. You might find it easier to engage one bracket and then the other. Lower the surround until both bracket sets are fully mated.
5. Carefully push the top of the surround with integrated screen so that the surround brackets slide into the rear detent of the mating brackets on the fireplace top. Carefully swing the bottom of the surround with integrated screen toward the base of the fireplace until the catch plates on the bottom flange of the surround are aligned with the spring loaded plungers on the bottom flanges of the lower surround mounting brackets.
6. To remove the surround with integrated screen, pull the bottom edge of the surround outward to disengage the spring loaded plungers and then lift the top up and off the upper brackets.
7. To prevent damage to the surround with integrated screen, always set the surround with integrated screen in a safe place while it is removed from the fireplace.

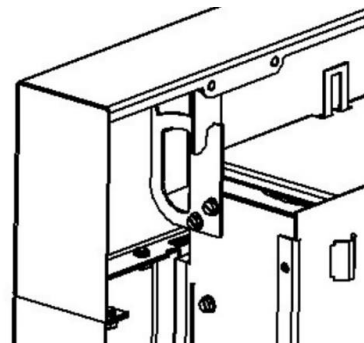
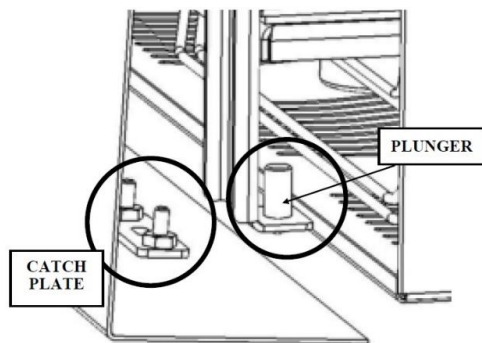
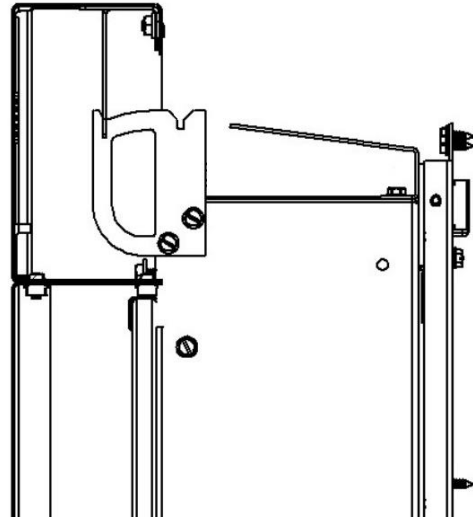

Lighting and Operation

FOR YOUR SAFETY READ BEFORE LIGHTING

WARNING: If you do not follow these instructions exactly, a fire or explosion may result causing property damage, personal injury or loss of life.



When lighting this appliance, follow these instructions exactly:

- A. This appliance is equipped with an ignition device that automatically lights the pilot. Do not try to light the pilot by hand.
- B. **BEFORE OPERATING THE BURNER SYSTEM**, smell around the appliance area for gas. Be sure to smell next to the floor because some gas is heavier than air and will settle on the floor.



WHAT TO DO IF YOU SMELL GAS

- 🔥 Do not try to light the appliance.
 - 🔥 Do not touch any electric switch; do not use any telephone in your building.
 - 🔥 Immediately call your gas supplier from a neighbor's telephone. Follow the gas supplier's instructions
 - 🔥 If you cannot reach your gas supplier, call the fire department.
- C. Use only your hand to operate the gas controls. Never use tools. If a knob will not push in or turn by hand, don't try to repair it, call a qualified service technician. Force or attempted repair may result in a fire or explosion.
 - D. Do not use this appliance if any part has been under water. Immediately call a qualified service technician to inspect the appliance and to replace any part of the control system which has been under water.

OPERATING INSTRUCTIONS

1. STOP! Read the safety information above on this label.
2. This appliance is equipped with an ignition device that automatically lights the pilot. Do not try to light the pilot by hand.
3. Using the Remote Handset, or the optional Wall Switch, push the "OFF"  button until you hear an audible signal to insure the appliance is Off.
4. Wait five (5) minutes to clear out any gas. Then smell for gas including near the floor. If you smell gas, STOP! Follow "B" in the safety information above. If you don't smell gas, proceed to step 5.
5. Using either the Remote Handset, or the optional Wall Switch, simultaneously press the "ON"  and "High Flame"  buttons. An audible signal confirms the start sequence has begun.
6. Continuing beeps confirm the ignition is in process. Once lighting the pilot flame should appear as shown in Fig.2. Once the pilot is confirmed, the main burner ignites on high.

NOTE: If the pilot does not stay lit after several tries, proceed to step 9.

7. Use the flame height adjustment buttons on either the Remote Handset or the optional Wall Switch to adjust the flame. Press the  button twice to decrease the flame height to its lowest setting, press the button twice to increase flame height to the highest setting. Pressing the  or  button once will module the flame to intermediate settings. The Remote Handset can also be used to control the appliance thermostatically.

8. Press and hold the  button on the Remote Handset or optional Wall Switch to set the appliance to Pilot flame only.
9. If the appliance will not operate, follow the instructions “TO TURN OFF GAS TO THE APPLIANCE” and call your gas service technician or gas supplier.

TO TURN OFF GAS TO THE APPLIANCE

1. To turn off gas to the appliance, push and release the  “OFF” button on either the Remote Handset or on the optional Wall Switch. You will hear an audible signal confirming the off setting.
2. TO TURN OFF THE GAS SUPPLY TO THE APPLIANCE, close the shut-off valve on the gas supply line to the appliance.

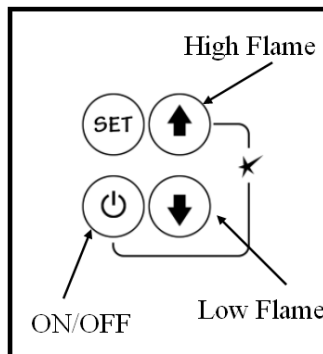

FIG. 1

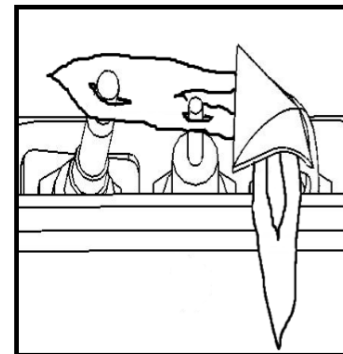

FIG. 2

OPERATING YOUR FIREPLACE FOR THE FIRST TIME

When operating your new fireplace for the first time, some vapors may be released due to the burning of curing compounds used in the manufacture of the appliance. They may cause a slight odor and could cause the flames to be the full height of the firebox, or even slightly higher, for the first few hours of operation.

It is also possible that these vapors could set off any smoke detection alarms in the immediate vicinity. These vapors are quite normal on new appliances. We recommend opening a window to vent the room. After a few hours use, the vapors will have disappeared and the flames will be at their normal height.

FLAME SUPERVISION DEVICE

For your safety, this appliance is fitted with a flame supervision device which will shut-off the gas supply if, for any reason, the pilot flame goes out. This device incorporates a fixed probe, which senses the heat from the pilot flame. If the probe is cool, the device will prevent any gas flow unless manually lighting the pilot. See full lighting instructions. Periodically check the pilot flame and compare to figure 2 above.

LIGHTING, OPERATION AND RATING INFORMATION

The Lighting, Operation and Rating information is located on a plate under the firebox.

To access the plate, remove any fret or access panel and grab the plate and slide it out to read it. There is important information on both sides of the plate.

WARNING

DO NOT ATTEMPT TO TOUCH THE DATA PLATE WHILE THE FIREPLACE IS STILL HOT!
Let the fireplace cool first before touching it.

SERVICING

If any attention is required for your appliance, contact your dealer quoting the model number. It will be helpful if the appliance’s serial number can also be quoted. This number is on the rating plate, which is located under the burner. The replacement parts are shown at the end of this manual. Please always quote the part number and description when requesting spare parts.

FIREPLACE CONTROL DEVICES

There are two ways to control your fireplace.

1. Thermostatic Remote Control
2. Optional Wall Switch

The Thermostatic Remote Control can be programmed to function automatically—see pages 34-39.

The Wall Switch (optional) can be used to turn on, off and to increase or decrease the flame height.

NOTE: The remote control in the AUTO mode will override the optional wall switch.

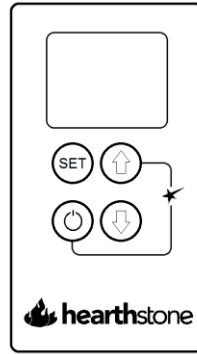

Programmable Thermostatic Remote Control

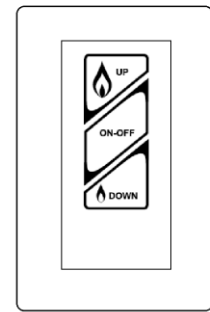

Optional Wall Switch

HOW TO TURN YOUR FIREPLACE OFF (INCLUDING PILOT)

Familiarize yourself with each of these methods before operating your fireplace.

Handset and Wall Switch: Press and hold the OFF button for a second (either on the handset or the wall switch).

If the flames are on, they go down and you hear the valve motor wind down. You hear a clunk and a beep indicating that the valve has received the signal from the remote control.

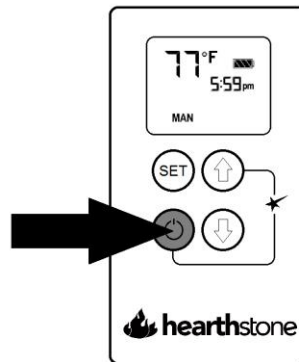

Programmable Thermostatic Remote Control

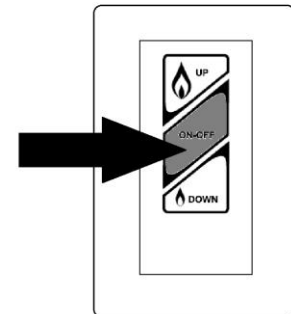

Optional Wall Switch

HOW TO ENSURE YOUR FIREPLACE CANNOT BE TURNED ON INADVERTENTLY

You can use the following method to ensure that your fireplace will not turn on when you don't want it on.

First, ensure your fireplace is turned off—including the pilot—and cold BEFORE going ahead.

- Close the shut-off valve on the gas supply line to the appliance.
- Remove all batteries from the receiver as well as the battery from the handset.

Automatic Shut-Off (in certain conditions)

Your fireplace's remote control is equipped with an automatic shut-off mechanism which is activated in certain conditions. See page 28 in the *Remote Control Operation* section for a description of this feature.

NOTE: Before using the remote control system for the first time, the receiver and the handset are synchronized at the factory. See the *Synchronizing the Remote and Valve Receiver Module* section under *Maintenance* on page 30 of this manual if the receiver and handset lose synchronization.

IMPORTANT: BEFORE YOU BEGIN, please note that on this system, the settings of time, temperature and automatic ON/OFF **can only be programmed when the function display is flashing.** Be patient when programming as it can take a few seconds to set.

Maxitrol Control System

Remote Control Layout

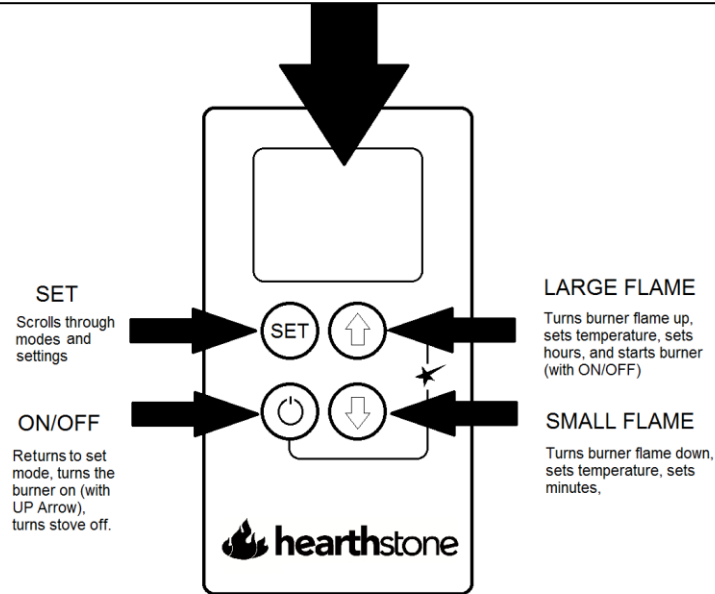
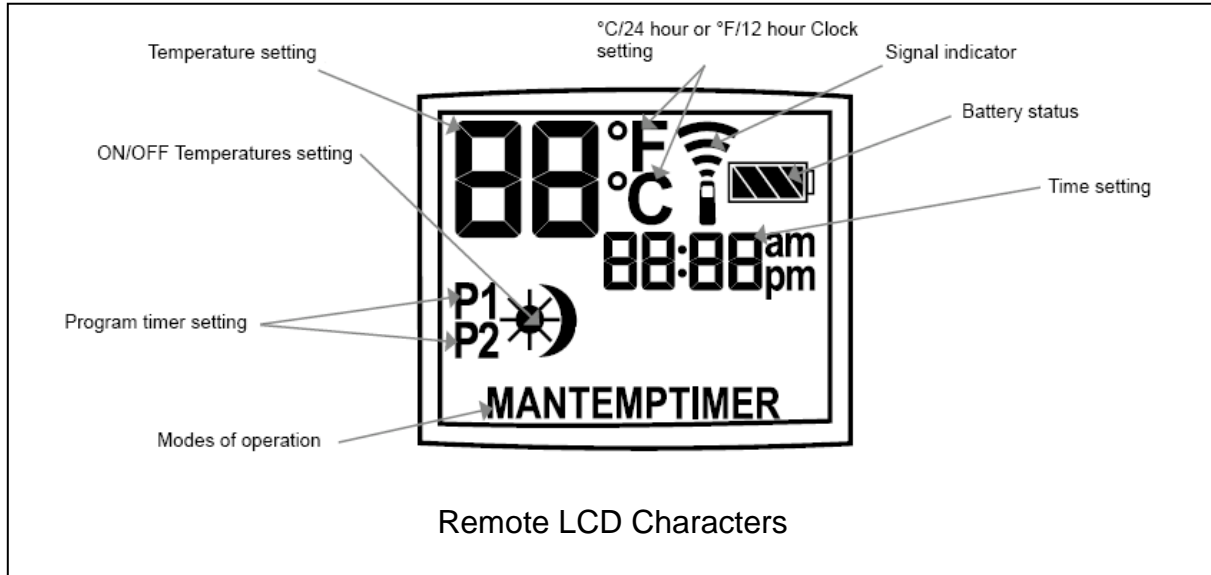

Handset Overview

Note: In the TEMP or TIMER modes, the remote handset senses the room temperature and adjusts the flame accordingly.

To communicate, the handset should be within 15 feet (4.5 meters) of the fireplace.

Do not leave the handset on the hearth, mantel, or on top of the fireplace.

BASIC REMOTE COMMANDS

TO TURN ON THE APPLIANCE

CAUTION

When pilot ignition is confirmed, motor turns automatically to maximum flame height.

- On the valve, turn MAN knob on the ON, full counterclockwise  position.

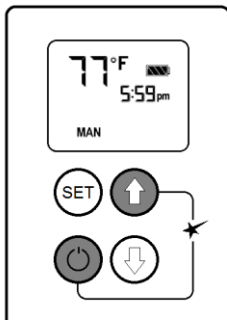

- Simultaneously press the OFF and  (large flame) buttons until a short beep confirms the start sequence has begun; release buttons.
- Continuing beeps confirm the ignition is in process.
- Once pilot ignition is confirmed, there is main gas flow.
- After main burner ignition the handset will automatically go into manual (MAN) control mode.

TO TURN OFF THE APPLIANCE

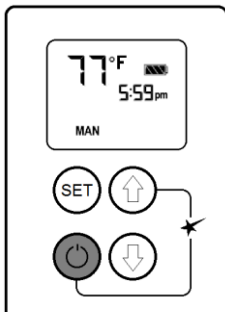



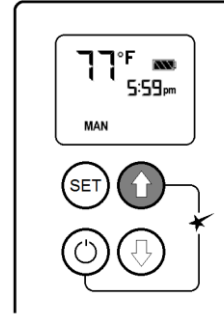

- Press OFF button.
- When the pilot is off, it will take 2 minutes before it can be lit again.

FLAME HEIGHT ADJUSTMENT

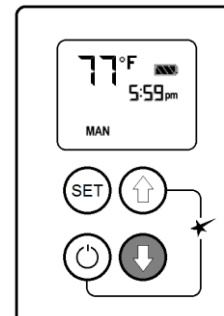



- In standby mode: Press and hold  (large flame) button to increase flame height.



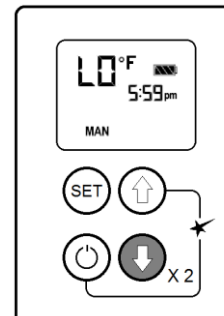

- Press and hold  (small flame) button to decrease flame height or to set the appliance at pilot flame.
- For fine adjustment tap the  (large flame) or  (small flame) buttons.

Express LO and HI Fire

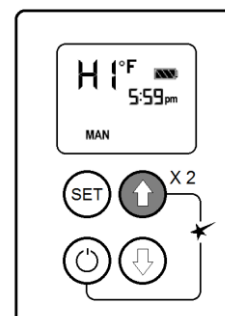

- Double-click  (small flame) button. "LO" will be displayed. NOTE: Flame goes to high fire first before going to designated low fire.



- Double-click  (large flame) button. Flame automatically goes to high fire. "HI" will be displayed.

SETTING C/24 HOUR OF F/12 HOUR

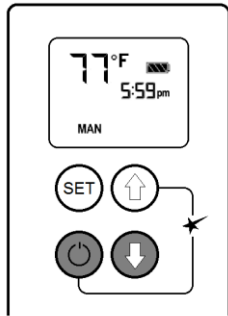

- In MAN mode, press OFF and (small flame) buttons until display changes from Fahrenheit/12-hour clock to Celsius/24-hour clock and vice versa.

SETTING THE TIME

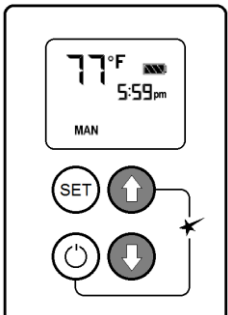

- The time display will flash after either: Installing the battery or simultaneously pressing the (large flame) and (small flame) buttons
- Press (large flame) button to set the hour.
- Press (small flame) button to set the minute.
- Press OFF or simply wait to return to MAN mode.

MODES OF OPERATION

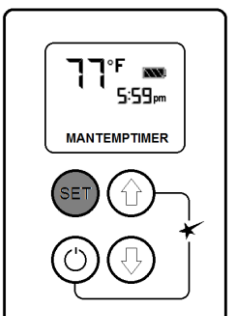

- Briefly pressing the SET button changes the mode of operation in the following order:

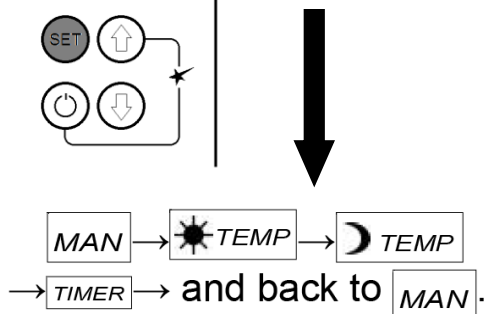

NOTE: Manual mode can also be reached by pressing either the (large flame) or the (small flame) buttons.

Whatever mode the remote is left in (MAN, TEMP, TIMER) is the mode the appliance will operate in until the mode is manually changed.

MANUAL MODE

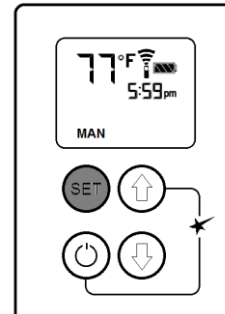

- In MAN mode, flame height is controlled by the up and down arrows. HO and LO commands function but otherwise is a “more or less flame” mode only.

DAYTIME TEMP MODE

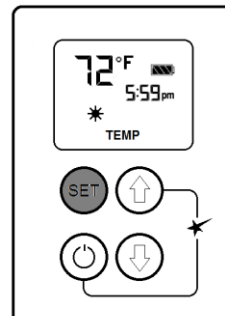

- (Appliance must be in standby mode; pilot ignited) - The room temperature is measured and compared to the set temperature. The flame height is then automatically adjusted to achieve the Daytime Set Temperature.

NIGHTTIME SETBACK TEMP MODE

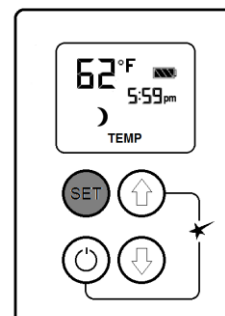

- (Appliance must be in standby mode; pilot ignited) - The room temperature is measured and compared to the set temperature. The flame height is then automatically adjusted to achieve the Nighttime Setback Temperature.

TIMER MODE

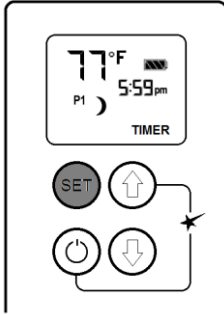

(Appliance must be in standby mode; pilot ignited)
The timers P1 and P2 (Program 1, Program 2) each can be programmed to go ON and OFF at specific times. For instructions see Timer Programming Mode.

NOTE: The display shows the set temperature every 30 seconds.

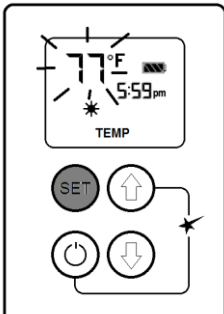

SETTING ON/OFF TEMPERATURES

SETTING THE “DAYTIME” TEMPERATURE

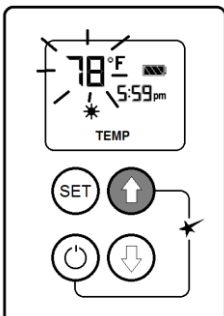

- Briefly press SET button to scroll to TEMP (sun) mode. Once there, hold the SET button down until the TEMP flashes.



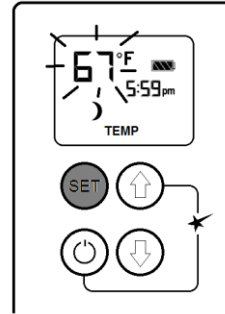

- Press  (large flame) button to increase the Daytime Set Temperature or press  (small flame) button to decrease Daytime Set Temperature.
- When finished, press OFF or wait for remote to re-set.

SETTING “NIGHTTIME SETBACK” TEMPERATURE

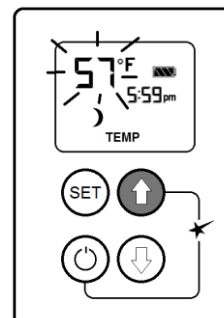

- Briefly press SET button to scroll to TEMP (moon) mode. Once there, hold the SET button until the TEMP flashes.



- Press  (large flame) button to increase the Nighttime Set back Temperature or press  (small flame) button to decrease Nighttime Setback Temperature.
- When finished, press OFF or wait for remote to re-set.

Tip

Set the different parameters only when they are flashing. For the Nighttime setback mode, pressing the down arrow until the LCD reads “- -” turns the Nighttime Setback Temp feature off.

SETTING PROGRAM TIMERS

Program timer mode allows the user to program a set time of day during which the appliance will operate to maintain a preset temperature (the Daytime Temp set above). When the appliance is not operating within this programmed time, it will revert to the Nighttime Setback Temp as programmed above.

Default settings:

Program 1: P1	6:00 am	P1	8:00 am
Program 2: P2	11:50 pm	P2	11:50 pm

Additional Information:

- 2 ON times can be programmed  per day.
- C/24hr. mode: The day starts at 0:00, ends at 23:50.
- F/12hr. mode: The day starts at 12:00^{am}, ends at 11:50^{pm}.
- The ON/OFF times have to be programmed in the order $P1 \text{ } \img alt="sun icon" data-bbox="180 180 195 195"/> \leq P1 \text{ } \img alt="moon icon" data-bbox="195 180 210 195"/> < P2 \text{ } \img alt="sun icon" data-bbox="245 180 260 195"/> \leq P2 \text{ } \img alt="moon icon" data-bbox="260 180 275 195"/>.$
- If $P1 \text{ } \img alt="sun icon" data-bbox="180 195 195 210"/> = P1 \text{ } \img alt="moon icon" data-bbox="195 195 210 210"/> or $P2 \text{ } \img alt="sun icon" data-bbox="245 195 260 210"/> = P2 \text{ } \img alt="moon icon" data-bbox="260 195 275 210"/> the timer is deactivated.$$
- To have the fire over night, it can be set:
 C/24hr. mode: $P2 \text{ } \img alt="moon icon" data-bbox="225 225 240 240"/> 23:50 and $P1 \text{ } \img alt="sun icon" data-bbox="180 225 195 240"/> 0:00$
 F/12hr. mode: $P2 \text{ } \img alt="moon icon" data-bbox="225 240 240 255"/> 11:50^{am} and $P1 \text{ } \img alt="sun icon" data-bbox="180 240 195 255"/> 12:00^{am}$$$

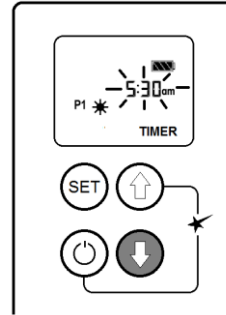

- Press the small flame arrow  to set the minute.

Setting P1 On Time:

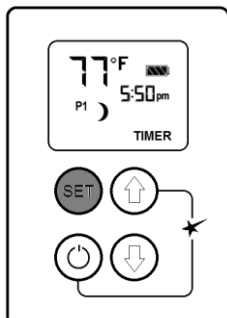

- Briefly press SET button to scroll to TIMER mode. P1 and the moon icon will also appear on the screen.

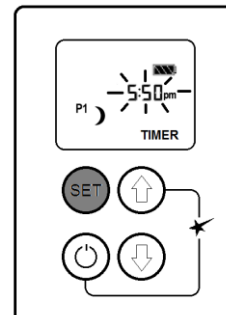

- Briefly press SET button to scroll to TIMER P1 mode (moon) while the time is still flashing.

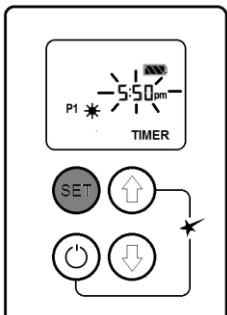

- Once there, hold the SET button down until the time of day flashes.

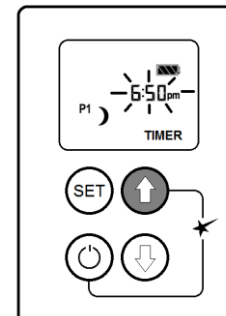

- Press the large flame arrow  to set the hour.

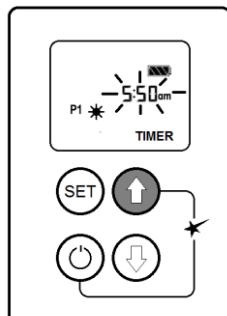

- Press the large flame arrow  to set the hour.

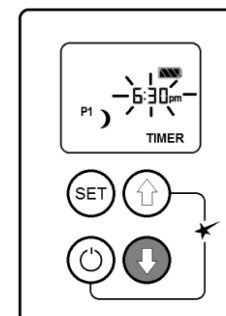

- Press the small flame arrow  to set the minute.

Setting P2 On Time

- While the time of day is still flashing, briefly press SET to scroll to TIMER mode **P2**  (sun).

- Follow the instructions given to set P1 ON time.

Setting P2 Off Time

- While the time of day is still flashing, briefly press SET to scroll to TIMER mode **P2** (moon).
- Follow the instructions given to set P1 OFF time.

Programming Example:

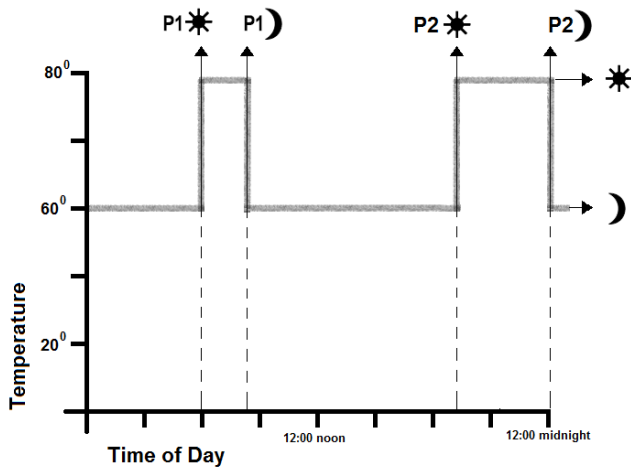

Appliance set to the following conditions will:

Increase temperature to 78 degrees from 6am to 8:45am each day, then return to 60 degrees until 7:30pm, at which time it will increase to 78 degrees until 12:00am, when it will return to 60 degrees and modulate there until 6:00am the following morning.

☀ Daytime temp set to 78°

☾ Nighttime temp set to 60°

P1☀ Program 1 daytime timer set to 6:00am

P1☾ Program 1 nighttime timer set to 8:45am

P2☀ Program 2 daytime timer set to 7:30pm

P2☾ Program 2 nighttime timer set to 12:00am

Tip

If you want to program only one period, program **P1** day and **P1** night with desired times and program **P2** day and **P2** night with the same time.

AUTOMATIC TURNDOWN

- **No communication.** If there is no communication between the receiver and the

handset for a period of 6 hours, the appliance goes into pilot mode.

- **No change in flame height.** If there is no change in flame height for a period of 6 hours, the appliance goes into pilot mode.

NOTE: In **TEMP** or **TIMER** modes, the flame height will vary according to room temperature. The appliance will continue to work normally. However, if the room temperature remains the same for 6 hours, the appliance will go into pilot mode.

AUTOMATIC SHUT OFF

- **Low batteries in the receiver.** With low battery power in the receiver the system shuts off completely.

NOTE: This does not apply when the power supply is interrupted.

- **No change in pilot.** The appliance shuts off completely when it is continually in pilot position— without any change—for a period of 5 days.

LOW BATTERY INDICATION

CAUTION

DO NOT USE a screwdriver or other metallic object to remove the batteries from the battery box or the handset! This could cause a short circuit.

- **Remote handset:** The battery icon  will show when the battery needs to be replaced. Replace with one 3 “AAA” **alkaline** batteries.
- **Receiver:** Three short ‘beeps’ will sound when the motor turns when the batteries need to be replaced. Replace with four 1.5 V **alkaline** batteries.
- **HANDSET / RECEIVER MATCH**
The remote control handset and receiver are program- med to function together. In case of a replacement of the handset or the receiver, you will need to reset the receiver to allow them to function together. Contact your dealer for details.

Maintenance

A qualified service agency should conduct an annual inspection and maintenance of your AIREs including the overall installation and venting to keep it running safely. The following procedures should be performed only by a qualified service person. The gas supply should be turned off and the stove should be completely cool whenever a maintenance procedure is performed. All parts of the appliance that are removed for servicing must be replaced prior to operation.

This appliance should be inspected before use and at least annually by a qualified service person. More frequent cleaning may be required due to excessive dust or lint from carpeting, bedding materials, pets, etc. It is imperative that control compartments and circulating air passageways of this appliance be kept clean.

CLEANING THE BURNER AND FIREBOX

During the annual inspection and maintenance appointment, the service person should clean the burner and firebox. To gain access to the firebox and burner, follow the instructions beginning on page 18 of this manual.

DO NOT USE A VACUUM CLEANER TO CLEAN THE GLASS BURNER MEDIA.

A vacuum cleaner may be used to clean the metal parts of the firebox. Leave the glass burner media in place. Use a soft brush to clean the burner glass media. If the burner media does need to be removed, carefully scoop it off the burner and avoid dropping glass pieces in the air gaps around the burner. Follow the instructions on page 16 of this manual when replacing the burner media on the burner top.

AIR FLOW

The AIREs Wall Mount Vent Free Gas Fireplace utilizes a convection air heat exchange system to maximize heat delivered from the fire-place. It is important that air flows freely through the convection air system and out the top and side air grills. Do not place objects under the fireplace that will block the convection air inlet flow or in front of any air outlet.

CLEANING THE GLOSS BLACK ENAMEL PANELS

After allowing the Fireplace to cool, use an ammonia-free glass cleaner and a soft, clean cloth to clean the Enamel Panels at the rear and side of the firebox. It is recommended that the Enamel Panels be cleaned at least annually to avoid discoloration. More frequent cleaning may be required if contaminants are present in the gas supply or general atmosphere.

WARNING: Never clean the Enamel Panels while they are hot. Do not use abrasive cleaners or cleaners containing ammonia.

NOTE: It is recommended that a Micro-fiber cleaning cloth be used to clean the enamel panels.

Synchronizing the Remote and Valve Receiver Module

A code is selected automatically for all Mertik Maxitrol electronics from among 65,000 random codes available. The receiver must learn the code of the handset, which is performed at the factory. If for any reason your appliance stops responding to remote commands, it may be necessary to re-sync the two components. To access the Valve Receiver Module, follow the instruction on page 16. Once you have access to the Receiver, press and hold the receiver's reset button (see figure below) until you hear two (2) beeps. The first beep is short and the second beep is long. After the second beep, release the reset button. Within 20 seconds press the Small Flame button on the handset until you hear two additional short beeps confirming the code is set. If you hear one long beep, this indicates the code has failed or the wiring is incorrect.



Step 1: Locate Reset Button on Receiver



Step 2: Press and hold Reset button until second beep is finished

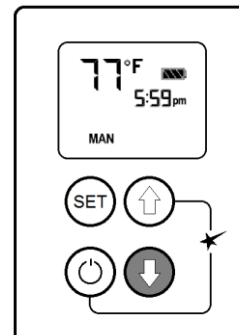

Step 3: Within 20 seconds, press Small Flame button on the remote

Maintenance Log

We strongly recommend that you keep a log of the regular maintenance that is performed on your fireplace. We have provided the forms below to make it easy. Simply ask your qualified service person to fill out one of the maintenance record forms below, each time the fireplace is serviced. This will help insure that all of the required maintenance procedures have been completed, at least annually. Regular maintenance will help keep the fireplace functioning in a safe and reliable manner. Additional forms are available from your installer or service person when needed.

Date of Service _____
Serviced By _____

Service Performed

- Clean Burner & Firebox
- Clean Control Area
- Clean Convection Air System
- Leak Test Gas Connections
- Other _____

Date of Service _____
Serviced By _____

Service Performed

- Clean Burner & Firebox
- Clean Control Area
- Clean Convection Air System
- Leak Test Gas Connections
- Other _____

Date of Service _____
Serviced By _____

Service Performed

- Clean Burner & Firebox
- Clean Control Area
- Clean Convection Air System
- Leak Test Gas Connections
- Other _____

Date of Service _____
Serviced By _____

Service Performed

- Clean Burner & Firebox
- Clean Control Area
- Clean Convection Air System
- Leak Test Gas Connections
- Other _____

Date of Service _____
Serviced By _____

Service Performed

- Clean Burner & Firebox
- Clean Control Area
- Clean Convection Air System
- Leak Test Gas Connections
- Other _____

Date of Service _____
Serviced By _____

Service Performed

- Clean Burner & Firebox
- Clean Control Area
- Clean Convection Air System
- Leak Test Gas Connections
- Other _____

Installation Record

The installer should complete the form below that describes the details of the installation. Having this written record of installation information available will greatly expedite trouble-shooting should any problem arise with your stove. The installer should keep a duplicate of this form for their records.

Date Purchased: _____

Dealer: _____

Date Installed: _____

Installer: _____

Fireplace Model: (circle one) ARIES 16 VF ARIES 26 VF ARIES 46 VF

Serial Number: _____ in. WC

Fuel: (circle one) Natural Gas (NG) Propane (LP)

Inlet Pressure (after installation): _____

Manifold Pressure (after Installation): High Fire: _____ in. WC

Low Fire: _____ in. WC

Altitude: (feet above sea level) _____

Was the stove de-rated? (circle one) Yes No

If the stove was de-rated, to what orifice size? _____

Other installation notes: _____

Replacement Parts List

PART NAME	P/N	PART NAME	P/N
Natural Gas (NG) Pilot Assembly	7211-396	TC Line Red	7000-069
Propane (LP) Pilot Assembly	7211-397	TC Line Yellow	7000-068
Receiver Module (Maxitrol)	7000-381	Thermocouple Interrupter Block	7000-067
Wall Switch Panel (Optional)	7000-260	8-Wire Connecting Cable	7000-044
Remote Handset (Maxitrol)	7000-362	Gas Valve (Maxitrol)	7211-308

ARIES 16 VF - REPLACEMENT PARTS

PART NAME	P/N	PART NAME	P/N
Burner Orifice (NG)	7200-200	Firebox Enamel Panel - Rear	99-76051
Burner Orifice (LP)	7200-201	Firebox Enamel Panel - Left	99-76052
Burner Glass Media (Black)	7211-763	Firebox Enamel Panel - Right	99-76053
Burner Module (NG)	99-74050	Burner Module (LP)	99-74051

ARIES 26 VF - REPLACEMENT PARTS

PART NAME	P/N	PART NAME	P/N
Burner Orifice (NG)	7200-202	Firebox Enamel Panel - Rear	99-76151
Burner Orifice (LP)	7200-203	Firebox Enamel Panel - Left	99-76152
Burner Glass Media (Black)	7211-764	Firebox Enamel Panel - Right	99-76153
Burner Module (NG)	99-74150	Burner Module (LP)	99-74151

ARIES 46 VF - REPLACEMENT PARTS

PART NAME	P/N	PART NAME	P/N
Burner Orifice (NG)	7200-204	Firebox Enamel Panel - Rear	99-76251
Burner Orifice (LP)	7200-205	Firebox Enamel Panel - Left	77-76252
Burner Glass Media (Black)	7211-765	Firebox Enamel Panel - Right	77-76253
Burner Module (NG)	99-74250	Burner Module (LP)	99-74251

For replacement parts and customer service, contact your Aurora dealer or:

Hearthstone Quality Home Heating Products, Inc.
 Technical Services
 317 Stafford Avenue
 Morrisville, VT 05661
www.hearthstonestoves.com

Maxitrol Control Schematic

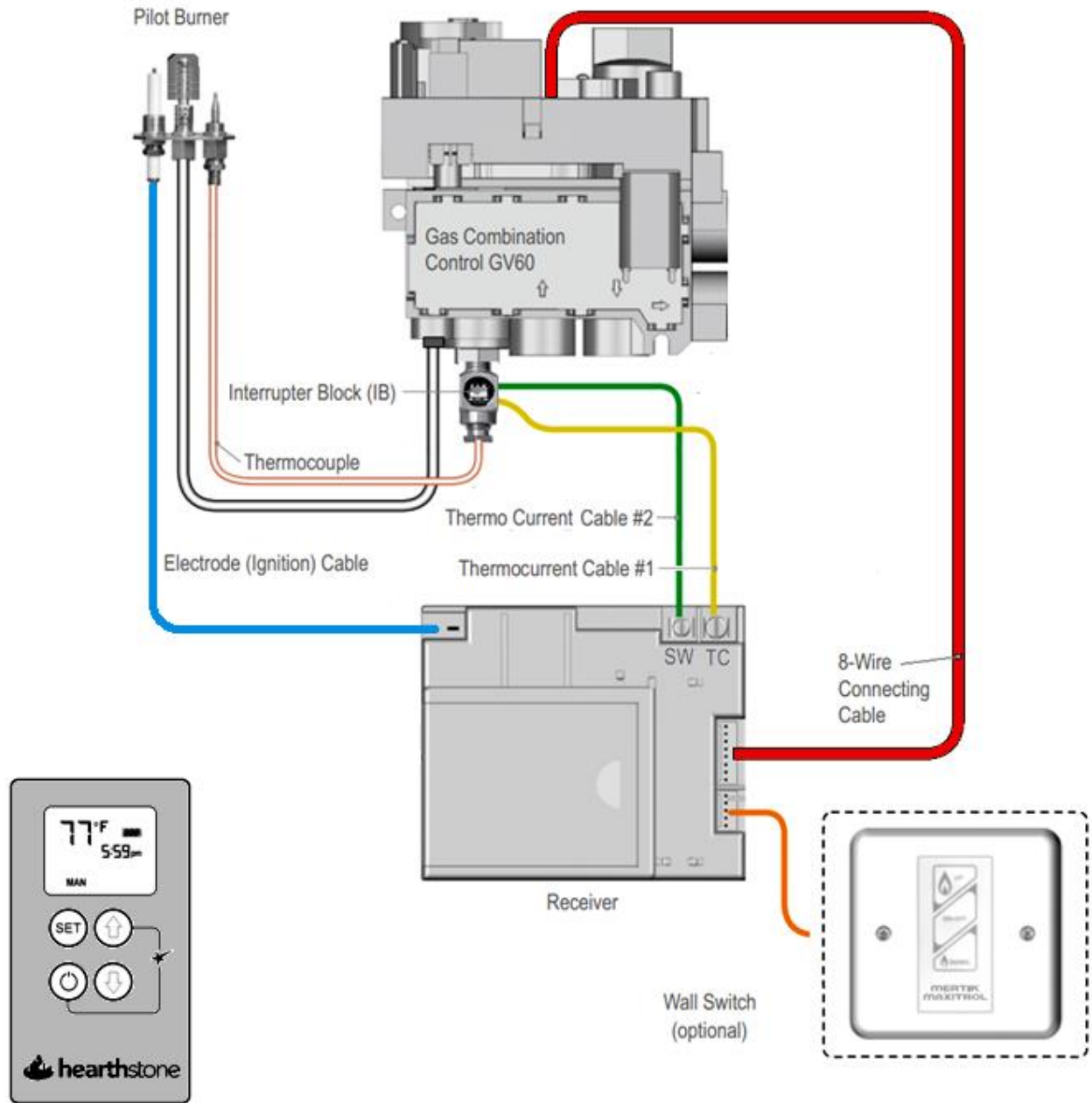

Maxitrol GV-60 Control System

Caution: Label all wires prior to disconnection when servicing the controls. Wiring errors can cause improper and dangerous operation. Verify proper operation after servicing.

Troubleshooting

Symptom	Possible Cause	Corrective Action
1. Pilot will not light.	<p>A. Optional Power supply not plugged in and/or batteries are dead.</p> <p>B. Insufficient gas pressure, air in the pilot line, or dirty or kinked gas line.</p> <p>C. Pilot orifice plugged.</p> <p>D. Defective or misaligned igniter element in pilot assembly.</p> <p>E. Defective igniter.</p> <p>F. After sitting for "off" season (summer), pilot assembly may be dirty.</p>	<p>A. Ensure power supply is plugged in and receiving 120V AC. Replace all batteries with known good batteries.</p> <p>B. Allow time for system to purge air in line. Check the inlet gas pressure. Make sure it is within the Min/Max. allowable pressures.</p> <p>C. Clean or replace the pilot assembly.</p> <p>D. If a flame lights the pilot, check the electrode gap and location. The gap should be 1/8" in the flame area.</p> <p>E. Check for a good connection between igniter and electrode. Check wire insulation. If everything is properly connected and still no spark, replace the Ignition Module.</p> <p>F. Clean or replace the pilot assembly.</p>
2. Pilot in Manual or Standby mode and will not stay lit after carefully following lighting instructions.	<p>A. Low or too high gas pressure</p> <p>B. Faulty connections.</p> <p>C. Pilot dirty or plugged.</p> <p>D. Thermocouple damaged.</p> <p>E. Thermocouple Interrupter circuit damaged.</p>	<p>A. Check for proper inlet pressure for the fuel gas in use.</p> <p>B. Check connections on the valve.</p> <p>C. Clean or replace the pilot assembly.</p> <p>D. Check for appropriate MV at thermocouple interrupter.</p> <p>E. Check thermocouple interrupter circuit for damage or loose connections.</p>
3. Pilot burning, no gas to main burner.	<p>A. Gas control system may be damaged.</p> <p>B. No power and/or batteries may be dead.</p> <p>C. Plugged burner orifice.</p>	<p>A. Check wiring for proper connections. Check components for proper operation. Check for appropriate MV output from thermocouple and check connections at thermocouple interrupter.</p> <p>B. Restore 120V service or replace batteries in receiver.</p> <p>C. Inspect burner.</p>
4. Pilot and burner come on, but go out after some warm-up.	<p>A. Inconsistent draft.</p> <p>B. Insufficient gas pressure.</p> <p>C. Excessive draft.</p>	<p>A. Check flue for blockage or other damage to venting.</p> <p>B. Check line pressure to ensure that the correct inlet pressure is present for the type of gas being used. If propane pressure is inconsistent, check for water condensation at the regulator.</p> <p>C. Check Restriction settings per this manual.</p>

Symptom	Possible Cause	Corrective Action
5. Frequent pilot outage.	A. Pilot flame may be too low or blowing, (high), causing the pilot safety to drop out. B. Excessive draft	A. Clean and/or adjust the pilot flame for maximum impingement on the thermocouple. B. Check Restriction settings per this manual.
6. Glass fogs	A. A normal result of gas combustion in a cold stove.	A1. After the heater has warmed up, the glass should clear. A2. Leave pilot in standby mode to keep stove warmer.
7. Blue Flames	A. A normal result during the first 20 minutes.	A. Flames should begin to turn more yellowish after 20 minutes of burning. B. If the blue color stays; adjust the air shutter for a proper burn.
8. Floating flames, lazy ill-defined, quiet flames, which roll around, sometimes completely off of the port, sometimes with overly, yellow tips. Possible sooting. Usually accompanied by the odor of aldehydes.	A. Potentially dangerous incomplete combustion due to incorrect air to fuel ratio (lack of combustion air or excessive fuel delivery I.e. excessive gas pressure, overrating of appliance). B. Incorrect air intake/exhaust flow system. Causes may be: B1. Blocked burner. B2. Blocked primary air B3. Blocked secondary air inlets C. Incorrect vent restrictor setting.	A. Check the appliance input rate and reduce if necessary. The air intake/exhaust flow system may be too restrictive or blocked (the rate at which the exhaust leaves [draft] determines the rate at which the combustion air is delivered). Poor draft results in insufficient air delivery or a restricted exhaust. Correct air intake/exhaust flow system. B1. Clear ports. B2. Clear obstructions. B3. Clear obstructions. C. If gas pressures are correct and the flames stay the same, check vent restrictor settings for a proper burn.
9. Burner flashback. Air-gas mixture ignites inside the burner near the orifice, usually creating a roaring noise like a blowtorch. The problem is an imbalance of gas flow velocity and burning speed pattern.	A. Excessive primary air. B. Burner input underrated. C. Valve leak if flashback occurs with burner valve in off position. D. Improper gas pipe size.	A. Adjust the air shutter for a proper burn. B. Check input rate. Check input pressure using a manometer. Confirm correct gas pressure at house meter or tank (call gas company). Confirm burner orifice size. C. Replace valve. If above corrections do not eliminate flashback, replace burner. D. Correct plumbing.
10. Delayed ignition (makes a sudden "whoosh" noise as the burner lights). This is a buildup of gas prior to ignition. This is more prevalent with propane (LP) fuel.	A. Incorrect air-to-fuel ratio. A1. Primary air incorrect. A2. Burner ports plugged.	A1. Adjust the air shutter for a proper burn. A2. Open ports to allow for proper travel of flames. B. Reposition media to eliminate interference with flame travel.

Limited Warranty

These warranties give you specific legal rights. You may also have other rights which vary from State to State.

Hearthstone Quality Home Heating Products, Inc. (Hearthstone) warrants to the original retail purchaser only (the "Original Purchaser") the new appliance manufactured by Hearthstone, purchased by the Original Purchaser and installed by an authorized Hearthstone dealer or their designated representative against any of the occurrences listed in this document that result from defects in material or workmanship. This warranty is not transferrable. All obligations of Hearthstone under this document commence on the date of the Original Invoice (the "Purchase Date"). The term "Limited Lifetime" is defined as 10 years from the beginning of warranty coverage.

Hearthstone appliances are designed to be operated only with the fuels listed in your owner's manual.

Burner – Repair or replacement for three years from date of installation.

Gas components & electrical components – Repair or replacement for one year from date of installation.

Blowers & remote controls – Repair or replacement for one year from the date of installation.

Porcelain Firebox Liners – Replacement for one year against cracking or breakage due to thermal stress from date of installation. Excludes surface and hairline cracks and scratches or slight color changes that do not affect the operation or safety of the unit.

Gaskets – Repair or replacement for one year from the date of installation.

Surrounds – Replacement for one year against cracking or breakage due to thermal stress. Excludes surface and hairline cracks and scratches or slight color changes that do not affect the operation or safety of the unit.

Any parts repaired or replaced during the limited warranty period will be warranted under the terms of the limited warranty for a period not to exceed the remaining term of the original limited warranty or one year, whichever is longer.

Parts: Hearthstone will replace through an authorized dealer, defective parts covered by the foregoing warranty at no charge.

Labor: Within the first (1st) year after the Purchase Date, Hearthstone will pay for warranty labor performed by an authorized Dealer at Hearthstone's published labor rates in effect at the time the labor is performed only if the appliance is installed by an authorized dealer or their designated representative. Otherwise or thereafter, the Original Purchaser is responsible for the cost of labor.

Shipping cost for parts: Within the first ninety (90) days after the Purchase Date, Hearthstone will pay for the shipping of appliance parts covered by any of the foregoing warranties to and from Hearthstone or an authorized Dealer, as the case may be. Thereafter, the Original Purchaser is responsible for all shipping costs related to shipping appliance parts to and from Hearthstone or an authorized Dealer, as the case may be.

Shipping cost for the appliance: Within the first (1st) year after the Purchase Date, if the Original Purchaser is instructed to return the appliance to Hearthstone or an authorized Dealer for repair, Hearthstone will pay fifty percent (50%) and the Original Purchaser will pay fifty percent (50%) of the shipping costs related to shipping the appliance to and from Hearthstone or an authorized Dealer, as the case may be. Thereafter, the Original Purchaser is responsible for one hundred percent (100%) of all of the shipping costs related to shipping the appliance to and from Hearthstone or an authorized Dealer, as the case may be. Notwithstanding any other provision of this document, in no event will Hearthstone pay

for any Dealer fees or other fees for pick up or delivery of the appliance returned for repair; the Original Purchaser shall be responsible for any such fees.

EXCLUSIONS & CONDITIONS

The warranties contained in this document do not cover, nor is Hearthstone responsible for:

1. Damages resulting from:
 - a. Failure to install, operate, or maintain the appliance in accordance with the owner's manual, operating instructions, installation instructions, or safety rating label provided with the appliance.
 - b. Over-firing the appliance. Over-firing can be identified by, but not limited to, warped cast iron or steel, rust colored cast iron, bubbling, cracking and discoloration of steel or enamel finishes.
 - c. Failure to install the appliance in accordance with all national or local building codes.
 - d. Shipping or improper handling.
 - e. Improper operation, abuse, misuse, continued operation with damaged, corroded, or failed components, accident, or improper/incorrect service or repairs.
 - f. Environmental conditions, inadequate ventilation, negative pressure, or improper drafting caused by tightly sealed constructions, insufficient make-up air supply, or air handling devices such as exhaust fans, forced air furnaces, or other such causes.
 - g. Damage caused by direct exposure to water.
 - h. Use of fuels other than those specified in the owner's manual.
 - i. Installation or use of components not supplied with the appliance, or any other components not expressly authorized and approved by Hearthstone.
 - j. Modifications of the appliance not expressly authorized and approved by Hearthstone in writing
 - k. Interruptions or fluctuations of electrical power supplied to the appliance.
2. All stones are warranted against cracking or breakage due to thermal stress, excluding surface and hairline cracks and scratches that do not affect the operation, or safety of the appliance.
3. Repair or replacement of wear parts. Such parts that are subject to normal wear and tear during the warranty period such as paint, gaskets, baffles, refractory materials, ash grates, and glass.
4. Damage resulting from installation, modification, alteration, repair or service of the appliance by any party other than an authorized Hearthstone dealer (a "Dealer") or their designated representative, or Hearthstone.
5. Damage due to water or condensation due to installation of the appliance in a high moisture area.
6. Damage due to installation of the appliance in an atmosphere contaminated by damaging chemicals, including but not limited to chlorine, fluorine or salts.
7. Scratches on glass, enameled surfaces or stones due to mechanical abrasion.
8. Noise caused by expansion or contraction caused by the heating and cooling of the appliance.
9. Odors caused by the heating of the appliance, or surrounding materials
10. Consequential damage caused by leaking of condensate during startup
11. A defect in any part of the appliance if the Original Purchaser fails to comply with Hearthstone's or a Dealer's request to ship the part or the appliance to Hearthstone or a Dealer, as the case may be.
12. Replacement stones and enameled parts are taken from current stock, and may not match originals in color, grain, or pattern. Hearthstone will supply replacement parts for discontinued parts in finishes or colors as available, or at their discretion.
13. Hearthstone's obligation under this warranty does not extend to the appliance's ability to heat the desired space. Information is provided to assist the customer and the dealer in selecting the appropriate appliance for the application. Consideration must be given to appliance location and configuration, environmental conditions, insulation and air tightness of the structure.

THE WARRANTIES CONTAINED IN THIS DOCUMENT ARE EXCLUSIVE AND ARE GIVEN BY HEARTHSTONE AND ACCEPTED BY THE ORIGINAL PURCHASER IN LIEU OF ALL OTHER EXPRESS WARRANTIES AND ANY OBLIGATIONS, LIABILITIES, RIGHTS, CLAIMS, OR REMEDIES IN CONTRACT OR TORT, WHETHER OR NOT ARISING FROM HEARTHSTONE'S NEGLIGENCE, ACTUAL OR IMPUTED. ALL IMPLIED WARRANTIES, INCLUDING THE WARRANTIES OF MERCHANTABILITY AND FITNESS FOR A PARTICULAR PURPOSE, ARE GIVEN ONLY TO THE EXTENT REQUIRED BY FEDERAL OR STATE LAW. EXCEPT AS OTHERWISE REQUIRED BY STATE LAW, UPON THE EXPIRATION OF THE EXPRESS LIMITED WARRANTIES CONTAINED

HEREIN, NO IMPLIED WARRANTIES, INCLUDING THE IMPLIED WARRANTIES OF MERCHANTABILITY OR FITNESS FOR A PARTICULAR PURPOSE, SHALL APPLY TO THE SUBJECT APPLIANCE. SOME STATES DO NOT ALLOW LIMITATIONS ON HOW LONG AN IMPLIED WARRANTY LASTS, SO THE ABOVE LIMITATION MAY NOT APPLY TO YOU.

THE WARRANTIES CONTAINED IN THIS DOCUMENT EXTEND ONLY TO THE ORIGINAL PURCHASER OF THE APPLIANCE WARRANTED HEREUNDER. THEY ARE NOT TRANSFERRABLE AND DO NOT EXTEND TO ANY SUBSEQUENT OWNERS.

UNDER NO CIRCUMSTANCES SHALL HEARTHSTONE BE LIABLE TO THE ORIGINAL PURCHASER OR ANY OTHER PERSON FOR ANY INCIDENTAL OR CONSEQUENTIAL DAMAGES, INCLUDING BUT NOT LIMITED TO DAMAGE TO PROPERTY OR PERSONAL INJURIES, WHETHER ARISING OUT OF LOSS OF USE, BREACH OF WARRANTY, TORT, OR OTHERWISE, EVEN IF HEARTHSTONE HAS BEEN APPRAISED OF THE POSSIBILITY OF SUCH DAMAGES. SOME STATES DO NOT ALLOW THE EXCLUSION OR LIMITATION OF INCIDENTAL OR CONSEQUENTIAL DAMAGES, SO THE ABOVE LIMITATION OR EXCLUSION MAY NOT APPLY TO YOU.

QUALIFYING FOR WARRANTY COVERAGE

To obtain performance of any obligation under this document, the Original Purchaser must, within the applicable warranty time period, contact their original Hearthstone dealer, or the current responsible local Hearthstone dealer, for instructions regarding the return of defective parts for repair, the return of the appliance for repair, or to schedule a Dealer service call. The Original Purchaser should refer to the Dealer Network search engine contained on Hearthstone's Web site (www.hearthstonestoves.com) if the original dealer is not available, to find a Hearthstone dealer nearest to the Original Purchaser's location.

REMEDY

The remedy for any breach of the foregoing warranties will consist of repair or replacement, at Hearthstone's option, of any covered defect in the appliance. When the Original Purchaser contacts a Hearthstone Dealer, the Dealer on behalf of Hearthstone, as the case may be, will instruct the Original Purchaser to either return the defective part, or the entire appliance (if requested), to the Dealer or Hearthstone or allow a Dealer to make a service call at the place where the appliance is located. Hearthstone may require that a digital picture be provided to support the claim. Notwithstanding any other provision of this document, the Original Purchaser shall pay for any fees and service charges related to a Dealer's service call or the shipping charges associated with the return.

WARRANTY REGISTRATION

The Original Purchaser can complete their warranty registration on our website at www.hearthstonestoves.com. Hearthstone's physical address is:

Hearthstone Quality Home Heating Products, Inc.
Warranty Department
317 Stafford Avenue
Morrisville, VT 05661

NOTE: ON-LINE REGISTRATION IS *NOT REQUIRED* AS A CONDITION OF WARRANTY COVERAGE OR HEARTHSTONE'S PERFORMANCE.